

■Features

- Single chip
- Super high brightness of surface mount LED
- Sorting for I_v and V_f @ 20mA of I_f
- Compact package outline
(LxWxT) of 1.0mm x 0.5mm x 0.4mm
- Compatible to IR reflow soldering.

■Applications

- Backlighting (switches, keys, etc.)
- Marker lights (e.g. steps, exit ways, etc.)

■Outline Dimension

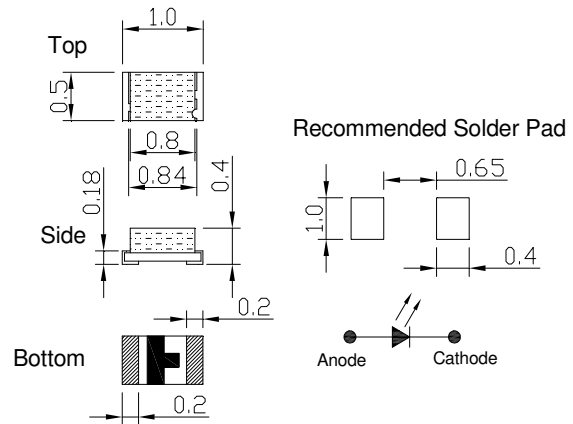

■Absolute Maximum Rating

($T_a=25^\circ\text{C}$)

Item	Symbol	Value		Unit
		R /Y/G/ O/Y	B/PG/W	
DC Forward Current	I_F	20	20	mA
Pulse Forward Current*	I_{FP}	100	100	mA
Reverse Voltage	V_R	5	5	V
Power Dissipation	P_D	52	72	mW
Operating Temperature	T_{opr}	-40 ~ +85		$^\circ\text{C}$
Storage Temperature	T_{stg}	-40~ +85		$^\circ\text{C}$
Lead Soldering Temperature	T_{sol}	260 $^\circ\text{C}$ /5sec		-



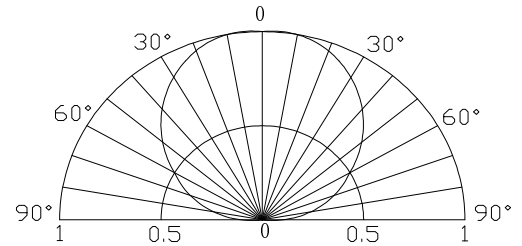





■Directivity



*Pulse width Max 0.1ms, Duty ratio max 1/10

■Electrical -Optical Characteristics

($T_a=25^\circ\text{C}$)

Part Number	Color			V_F (V)			I_R (μA)	I_v (mcd)			λ_D (nm)			$2\theta_{1/2}$ (deg)
				Min.	Typ.	Max.	Max.	Min.	Typ.	Max.	Min.	Typ.	Max.	Typ.
				$I_F=20\text{mA}$			$V_R=5\text{V}$			$I_F=20\text{mA}$				
OSM50402C1C	Warm White	M5		2.8	3.2	3.6	10	250	400	600	3000-3500K			120
OSWA0402C1C	Pure White	WA		2.8	3.2	3.6	10	250	400	600	6500-9000K			120
OSB50402C1C	Blue	B5		2.8	3.2	3.6	10	60	90	150	465	470	475	120
OSG50402C1C	Pure Green	G5		2.8	3.1	3.6	10	250	400	600	520	525	530	120
OSG80402C1C	Yellow Green	G8		1.8	2.0	2.6	10	20	30	40	565	570	575	120
OSY50402C1C	Yellow	Y5		1.8	2.0	2.6	10	50	100	200	585	590	595	120
OSO50402C1C	Orange	O5		1.9	2.2	2.6	10	50	100	200	600	605	610	120
OSR50402C1C	Red	R5		1.8	2.0	2.6	10	50	100	200	620	625	630	120

Note: * V_f tolerance: $\pm 0.05\text{V}$ * Dominant wavelength tolerance: $\pm 1\text{nm}$

* Luminous intensity is NIST reading. Luminous intensity tolerance: $\pm 10\%$

■ Optical and electrical characteristics

TYPICAL ELECTRICAL/OPTICAL CHARACTERISTIC CURVES

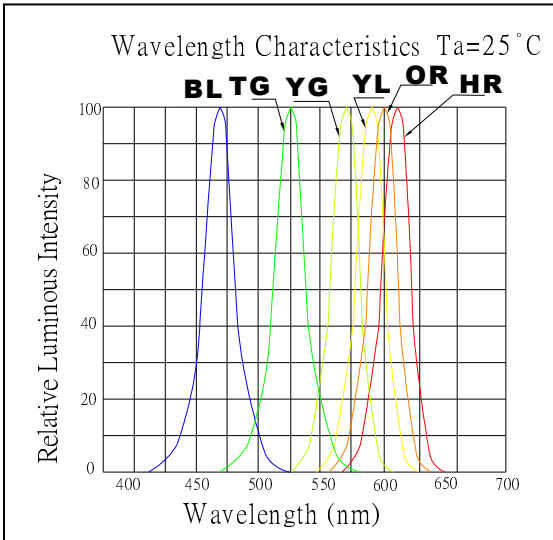
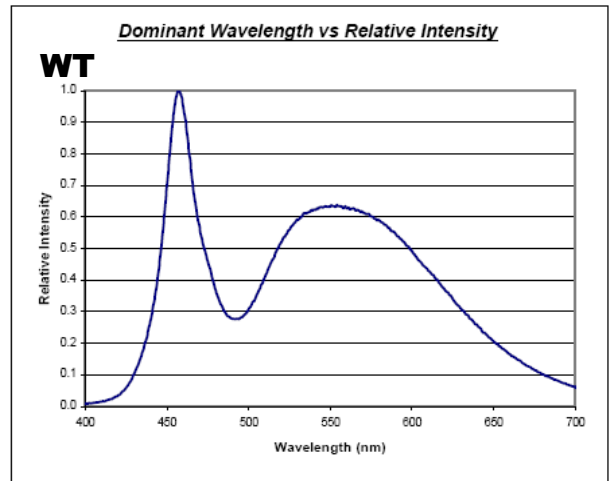
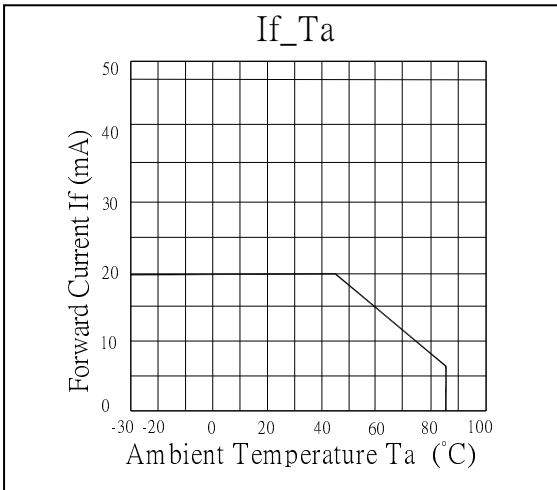
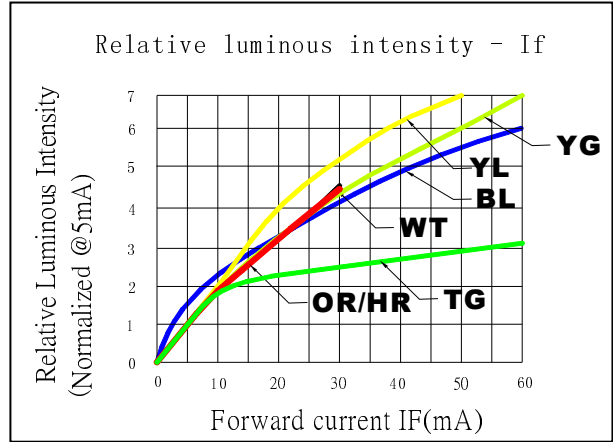
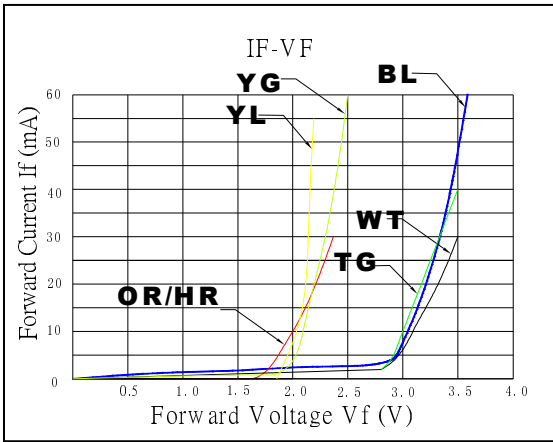

■ **Recommended Soldering Temperature – Time Profile (Reflow Soldering)**

Surface Mounting Condition

In automatic mounting of the SMD LEDs on printed circuit boards, any bending, expanding and pulling forces or shock against the SMD LEDs should be kept min. to prevent them from electrical failures and mechanical damages of the devices.

Soldering Reflow

- Soldering of the SMD LEDs should conform to the soldering condition in the individual specifications.
- SMD LEDs are designed for Reflow Soldering.
- In the reflow soldering, too high temperature and too large temperature gradient such as rapid heating/cooling may cause electrical & optical failures and damages of the devices.
- We cannot guarantee the LEDs after they have been assembled using the solder dipping method.

1) Lead Solder

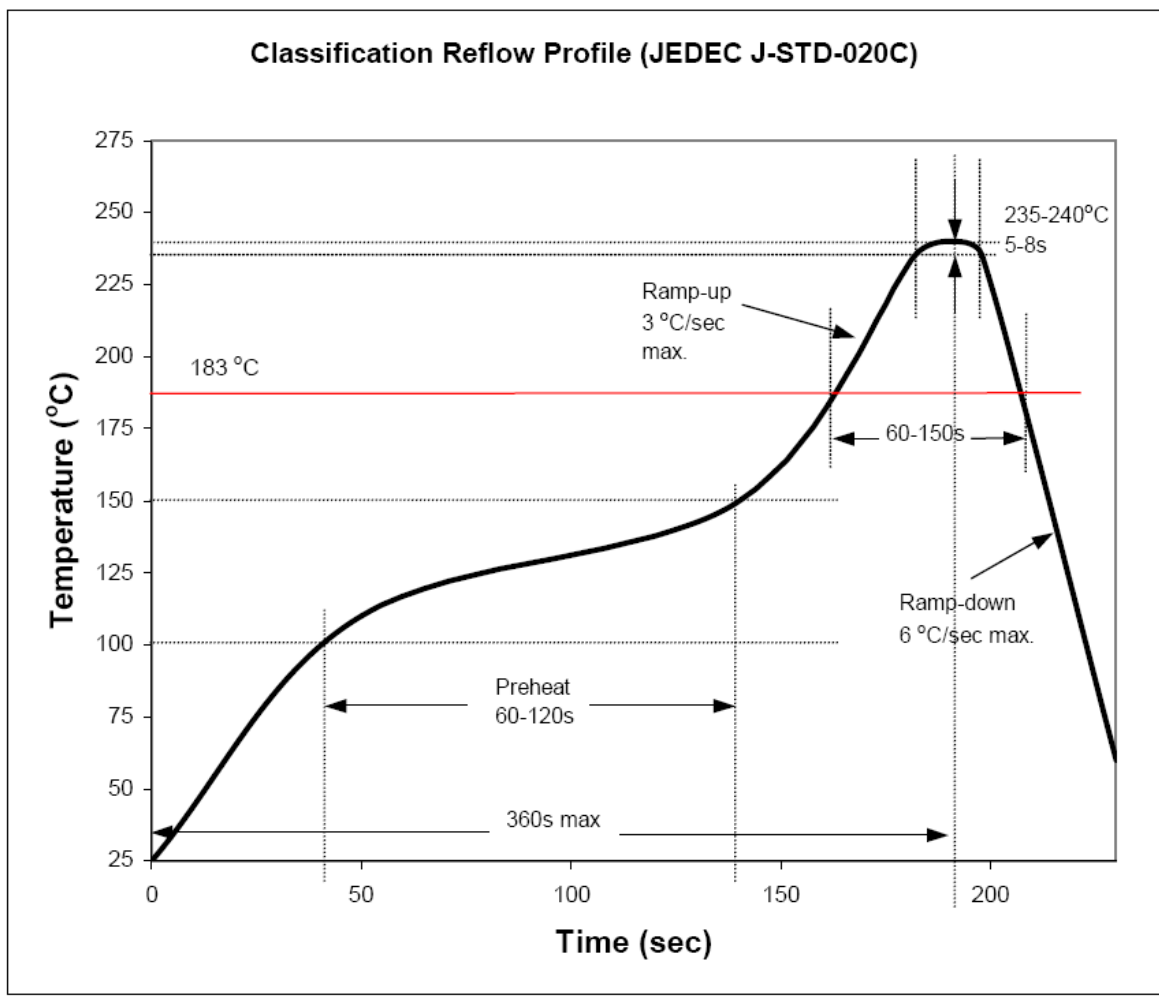

2) Lead-Free Solder

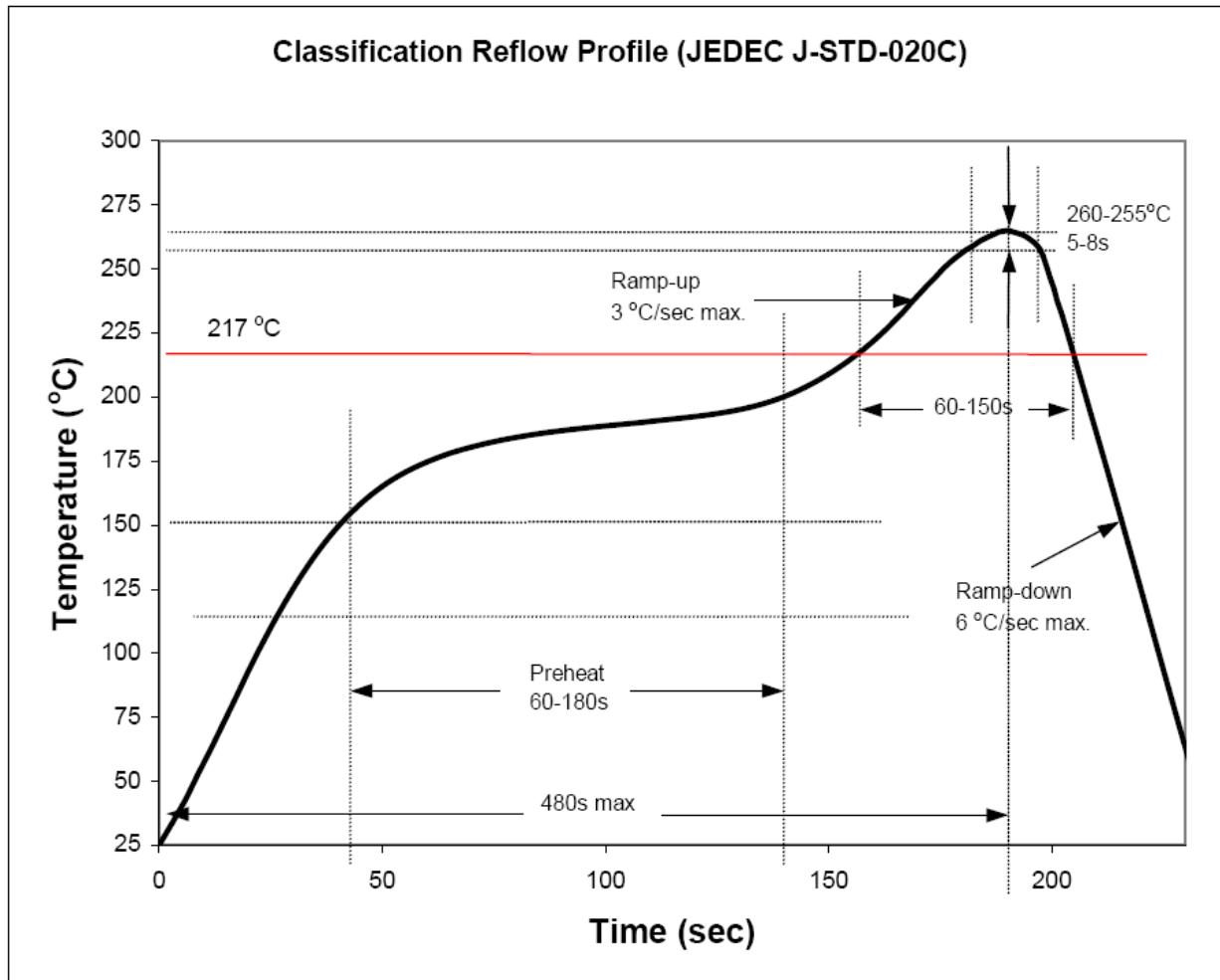

3) Manual Soldering conditions.

- Lead Solder

Max. 300 for Max. 3sec, and only one time. °C

- Lead-free Solder

Max. 350 for Max. 3sec, and only one time. °C

- There is possibility that the brightness of LEDs is decreased, which is influenced by heat or ambient atmosphere during reflow. It is recommended to use the nitrogen reflow method.

- After LEDs have been soldered, repair should not be done. As repair is unavoidable, a double-head soldering iron should be used. It should be confirmed beforehand whether the characteristics of the LEDs will be damaged by repairing or not.

- Reflow soldering should not be done more than two times.

■ **Material**

White/ Blue/ Yellow green/ Yellow/ Orange/ Red /True green :

	Material
1. Lead-frame. / Soldering Leads	Cu Alloy With Ni, Au Plating.
2. PCB	BT Resin.
3. Encapsulate	Epoxy Resin.
4. Die	AllnGaP based
5. Bonding wire	Au Chip : Ball Bonding / PCB : Ball Bonding

Note: Product is lead-free (Pb free).

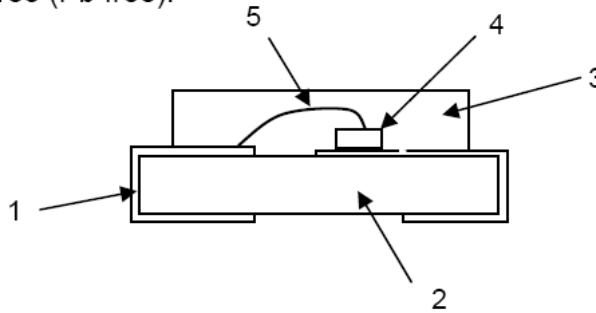

■ Taping and Orientation.

1. Quantity:4000pcs 2. Diameter: 178 mm 3. General Tolerance : ± 0.1

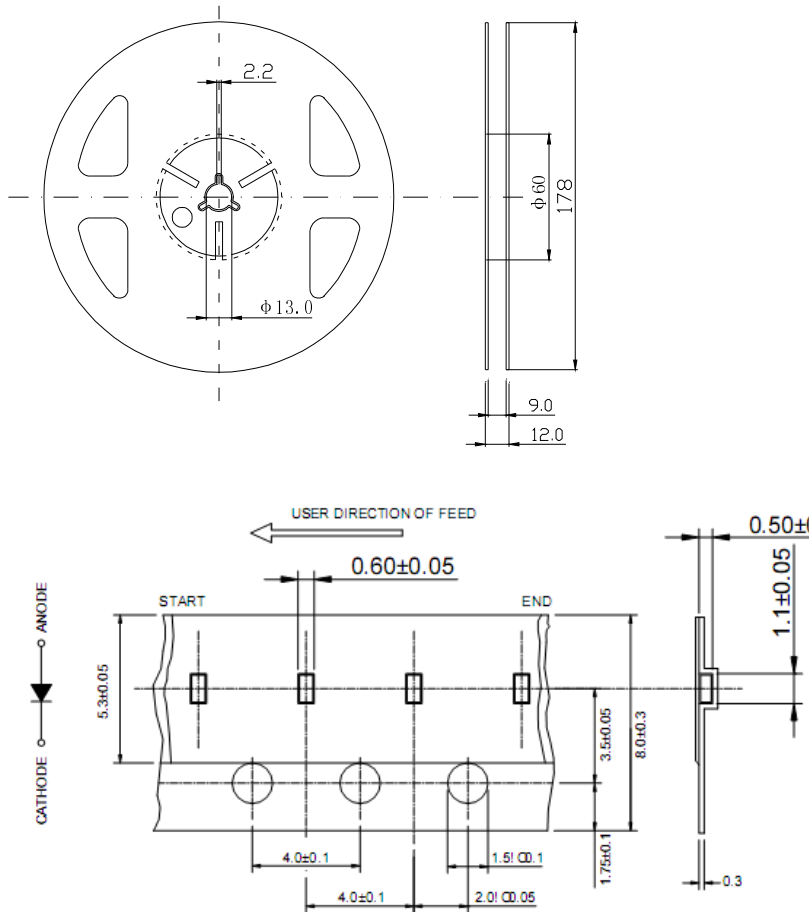

■ Cautions:

1. After open the package, the LED should be kept at 30 °C, 30%RH or less. The LED should be soldered within 24 hours (1 day) after opening the package.
2. Heat generation must be taken into design consideration when using the LED.
3. Power must be applied resistors for protection, over current would be caused the optic damage to the devices and wavelength shift.
4. Manual tip solder may cause the damage to Chip devices, so advised that heat of iron should be lower than 15W with temperature control under 5 seconds at 230-260 deg. C. (The device would be got damage in re working process, recommended under 5 seconds at 230-260 deg. C)
5. All equipment and machinery must be properly grounded. It is recommended to use a wristband or anti-electrostatic glove when handing the LED.
6. Use IPA as a solvent for cleaning the LED. The other solvent may dissolve the LED package and the epoxy, Ultrasonic cleaning should not be done.
7. Damaged LED will show unusual characteristics such as leak current remarkably increase, turn-on voltage becomes lower and the LED get unlight at low current.

■ Reliability Test :

	Test Item	Test Conditions	Time	Test Q'ty	Fail Q'ty	O.K
1	Thermal Cycle Test (168 cycles)	H:+75°C 30 min ~ L:-35°C 30 min	168 Hrs	20	0	Pass
2	Thermal Shock Test (84 cycles, Rate= 5min)	H:+85°C (Holding 1 hr) ~ L:-40°C (Holding 1 hr)	168 Hrs	20	0	Pass
3	High Temp. Storage Test	Temp.:100°C	168 Hrs	20	0	Pass
4	Low Temp. Storage Test	Temp.: -40°C	168 Hrs	20	0	Pass
5	High Temp. High Humidity Test	85°C/85%RH,	168 Hrs	20	0	Pass
6	Press Cook Test	T=121°C, P=2atms H=100%RH	168 Hrs	20	0	Pass
7	Operating Life Test	IF=20 mA, 25°C	168 Hrs	20	0	Pass
8	IR-Reflow Test	Max 260°C (Pb free condition)	2 Times	10	0	Pass

Conclusions:

The reliability tests were designed to evaluate both package integrity as well as workability of product performance over time.

All samples have done well by completed test requirement and passed all the qualification criteria with zero failure. From design standpoint, the package is robust enough to meet its datasheet conditions. Based on the good result shows on the above test, this product is qualified and released for market.